

English

CT9R

ASSEMBLY INSTRUCTION

Thanks for purchasing one of our products, please read carefully the assembly instructions before installation (Attention: Do not tighten the screws before all screws are in place).

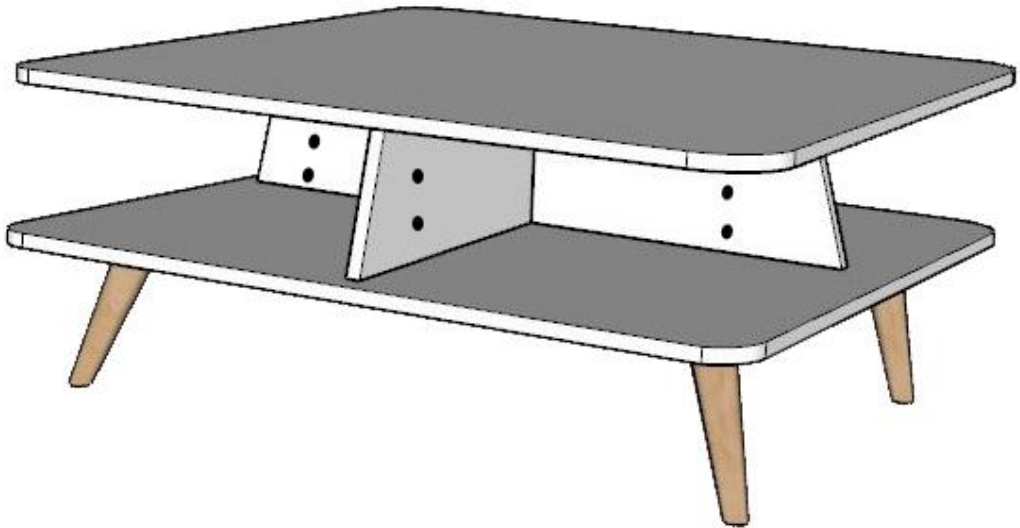

TWO PEOPLE REQUIRED

General Care:

- Keep your furniture out on direct sunlight-Use desk pads and coasters to protect the surface from dents, scatches and moisture from hot and cold liquids.

Cleaning:

- For cleaning, wipe the surface with a damp (not with) cloth or wipe dry with a clean lint free cotton cloth.
- Window cleaning liquid or a similar cleaning liquid can be used to clean glass surfaces

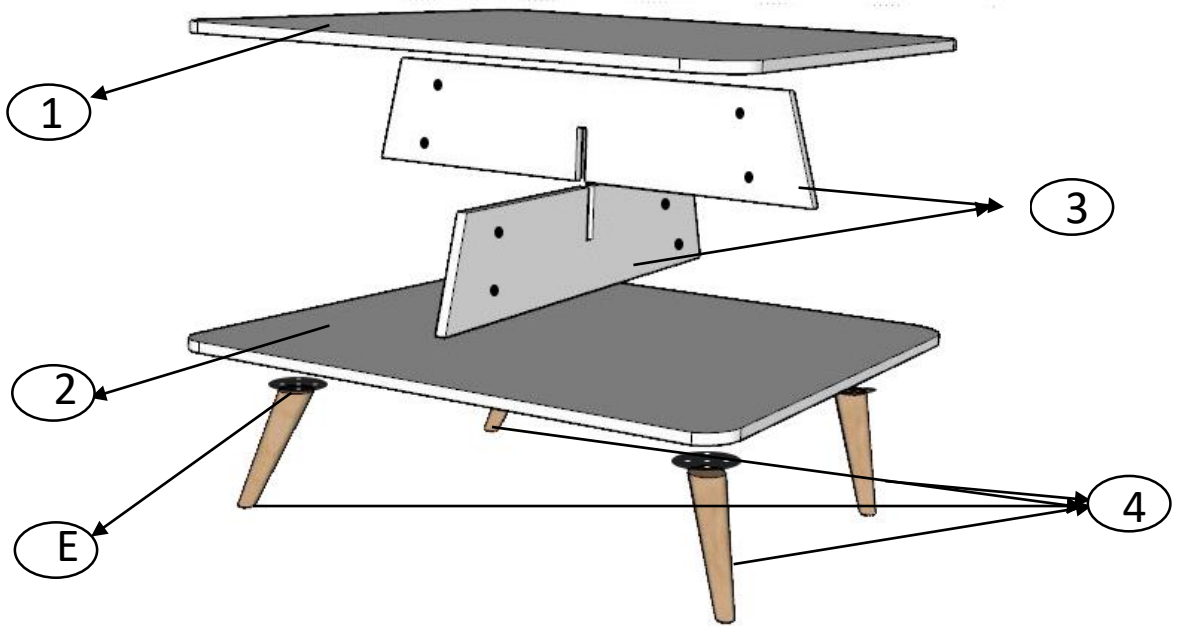



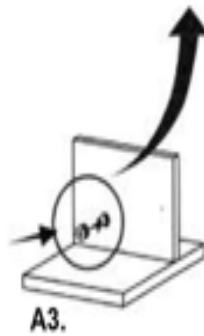
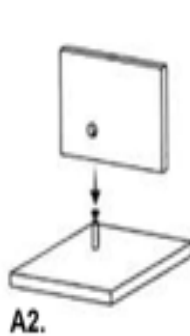
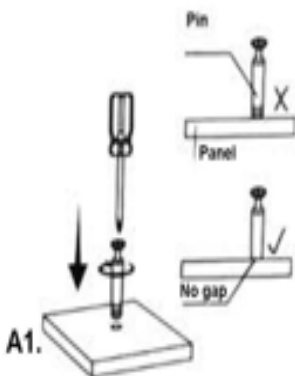
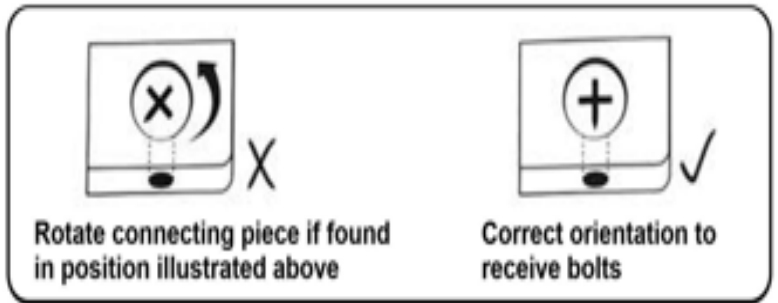
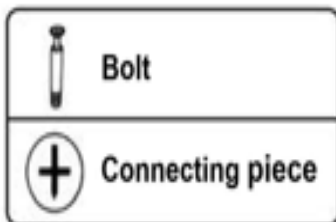

6x40 MM BOLTS INSTALLATION AS BELOW



• PARTS LIST

ITEMS LIST		QTY
1	TOP PANEL	1 PC
2	BOTTOM PANEL	1 PC
3	MIDDLE PANELS	2 PC
4	WOODEN LEG	4 PC

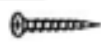
• SCREW LIST

HARDWARE			
A	MINI FIX  		8 SET
B	DOWLES		8 PCS
C	M6 X 16 SCREW 		12 PCS
D	M6 X 32 SCREW 		8 PCS
E	FLANGE		4 PCS

1



2

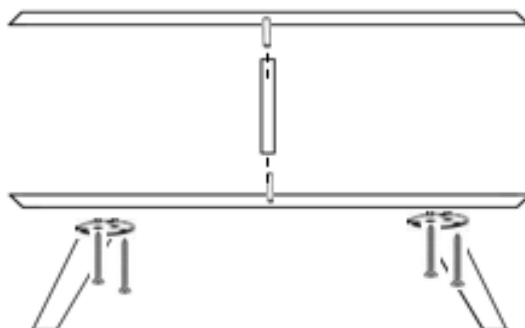

3

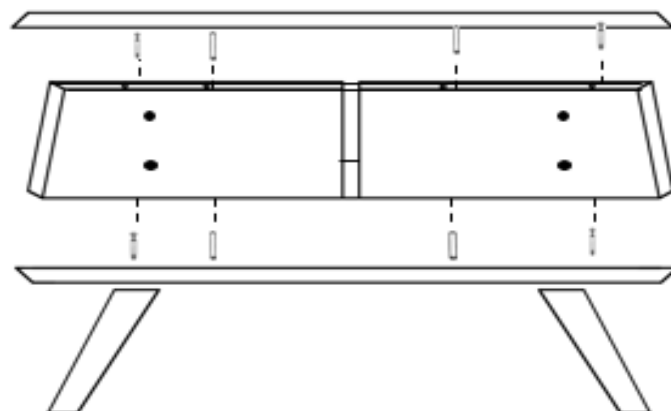

CONGRATULATIONS!!!

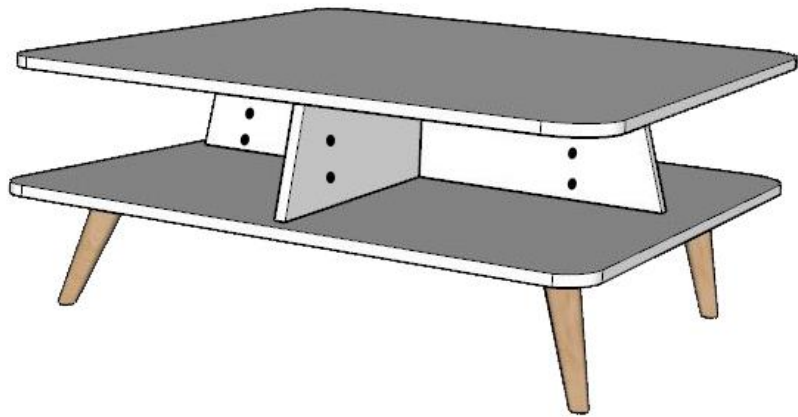

GUDSMITH